

Description

SAU supply air units are designed to give a pleasant indoor environment. They provide both heat and clean air. The units are supplied complete with filter, fan and heater. SAU125 and 200 can be operated using a dual controller; Heater on/off and fan speed 0/1/2. It is also possible to regulate externally using a pulser. SAU 250 with a water battery is operated using a 3-way valve and control equipment. The range is manufactured using galvanized sheet metal. The units are insulated with 50mm of mineral wool allowing for use in both warm and cold areas. Alternative filters are available; G4, F4 and F7 (G4 as standard).



Technical data

Parameter	Value	Unit
Voltage	3x400	V
Phase	1	~
Frequency	50	Hz
Input power, fan	105	W
Input power, heater	5000	W
Input power, total	5105	W
Current	12.7	A
Sound pressure level at 3 m	44	dB(A)
Length	1071	mm
Width	486	mm
Height	352	mm
Weight	33	kg
Enclosure class, motor	44	IP
Insulation class, motor	F	
Duct connection	ø200 mm	

Diagrams

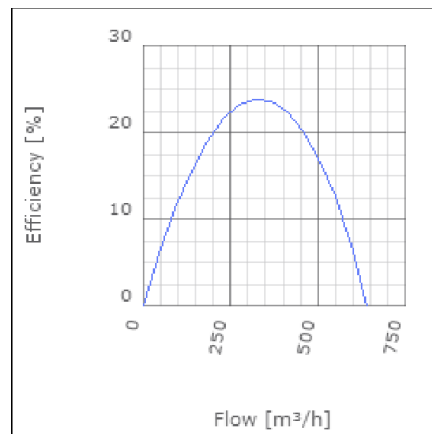
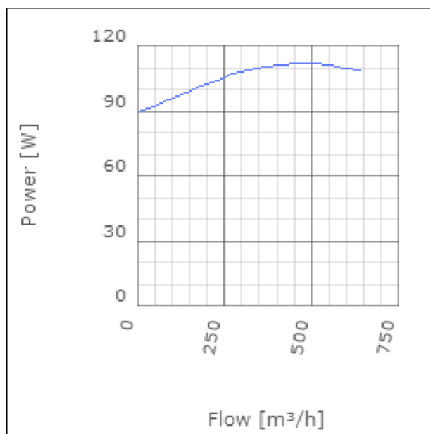
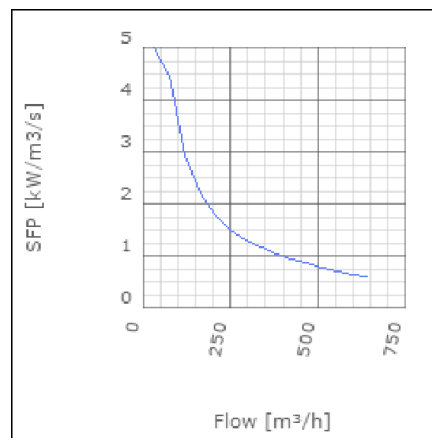
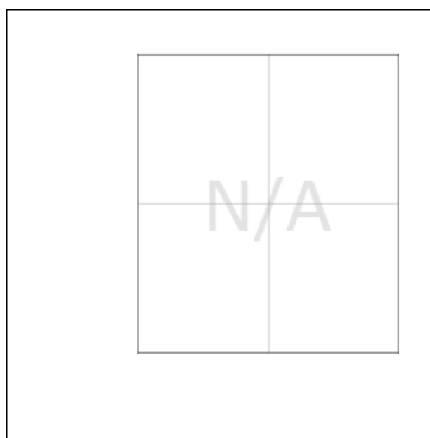
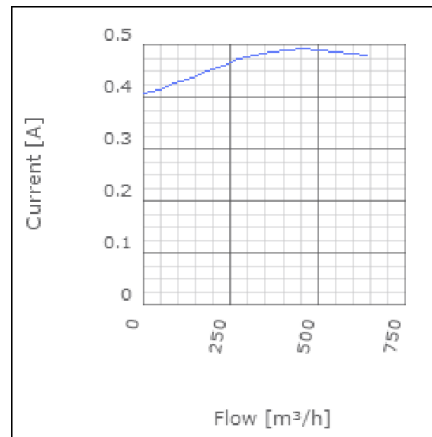
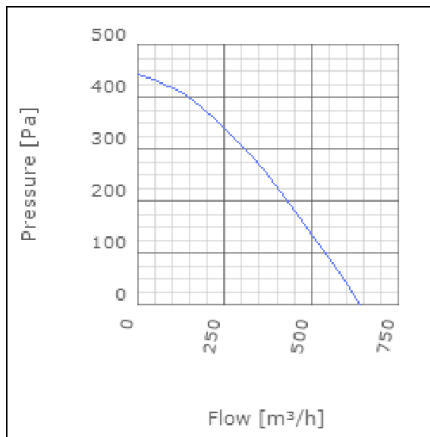

Sound

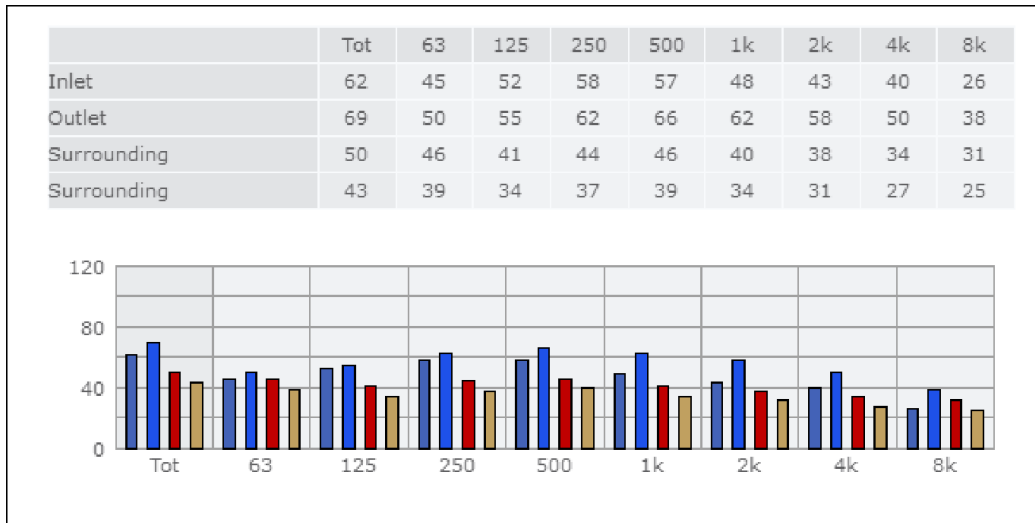

Parameter

Distance: 3.000
 Propagation type: Hemi-spherical
 Equivalent absorption area: 20.00

Checked point

Flow 339.209m³/h
 Static pressure 276Pa

Working point

Flow 340.372m³/h
 Static Pressure 278Pa
 Power 110W
 Speed 0r/s
 Current 0.49A
 Voltage 230V
 Efficiency 23.885%
 SFP 1.16kW/m³/s

Dimensions

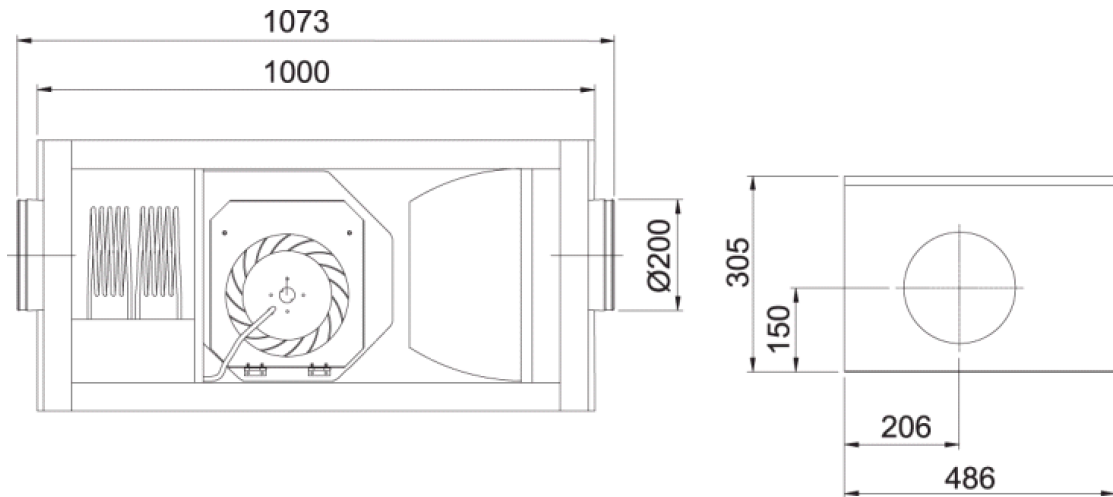

Wiring diagram

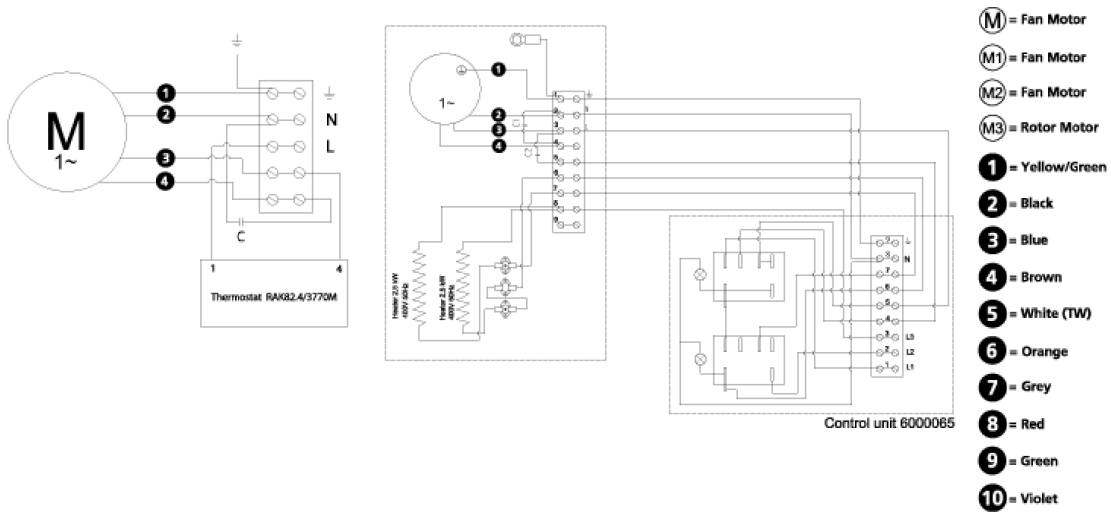

Accessories

Electrical accessories

- SAU 200 Filter
- LDC 200