

TKV/TKH 560 B3

Description

Our new, unique and patent pending roof fans you can easily modify for either horizontal or vertical outlet. Equally easy to clean and maintain. They achieve a higher airflow compared to the previous models but with even lower sound levels.

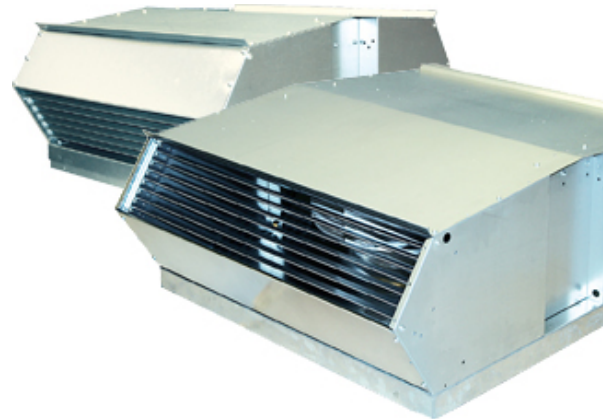

Technical data

Parameter	value	Unit
Voltage	400	V
Phase	3	~
Frequency	50	Hz
Power	332	W
Current	0,59	A
R.p.m.	1290	r.p.m.
Max. temperature of transported air	40	°C
Max. temperature of transported air when speed-controlled	40	°C
Sound pressure level at 10 m	49	dB(A)
Weight	24	kg
Enclosure class, motor	44	IP
Insulation class, motor	F	
Capacitor	-	µF

Diagrams

○ Selected point

Flow [l/s]	606
Stat. pres. [Pa]	210
● Work point	
Flow [l/s]	606
Stat. pres. [Pa]	210
Power [W]	323
Current [A]	0,577
Speed [r.p.m.]	1301
Efficiency [%]	39,4
SFP [kW/m ³ /s]	0,526
Voltage [V]	400

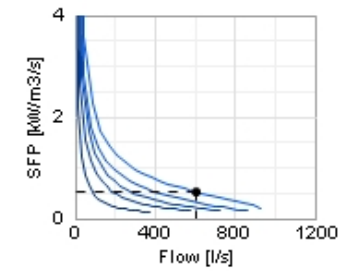
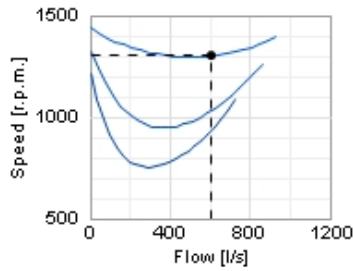
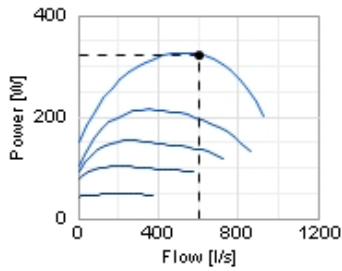
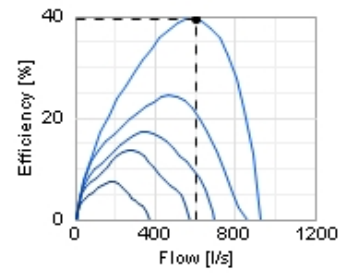
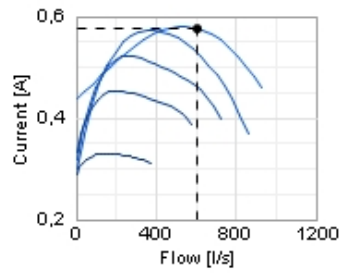
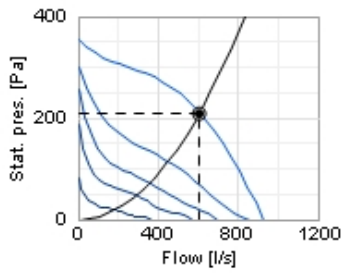

Sound

○ Selected point

Flow [l/s]	606
Stat. pres. [Pa]	210
● Work point	
Flow [l/s]	606
Stat. pres. [Pa]	210
Total press. [Pa]	245
Power [W]	323
Current [A]	0,577
Speed [r.p.m.]	1301
Efficiency [%]	39,4
SFP [kW/m ³ /s]	0,526
Voltage [V]	400

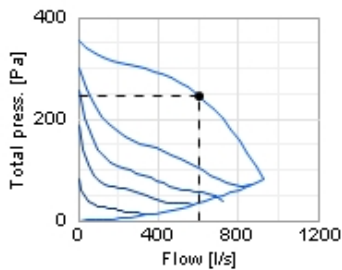
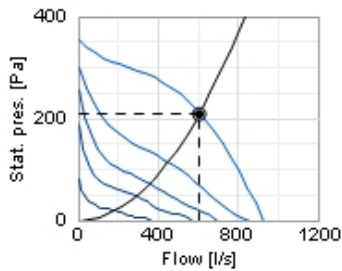

Distance: 3

Propagation type: Semi-spherical

Equivalent absorption area: 20

	Tot	63	125	250	500	1k	2k	4k	8k
Inlet Lw dB(A)	80	65	73	74	72	71	70	67	60
Surrounding Lw dB(A)	77	40	55	64	68	72	73	66	58
Surrounding Lp dB(A)	70	34	48	58	61	65	66	59	51

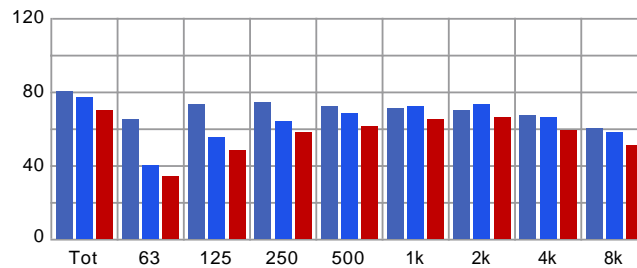

Dimensions

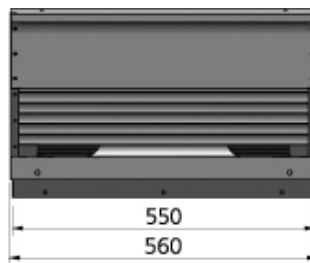
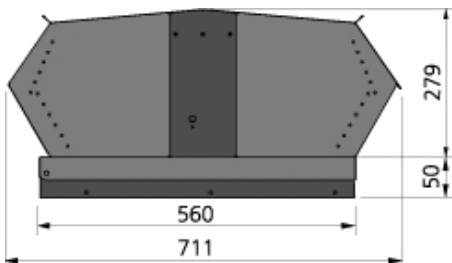

Wiring diagram

4040004

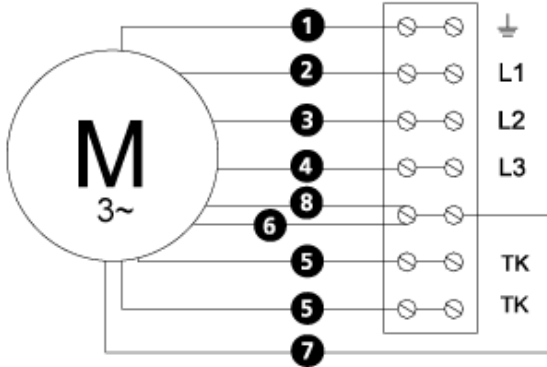

- (M) = Fan Motor
- (M1) = Fan Motor
- (M2) = Fan Motor
- (M3) = Rotor Motor
- 1 = Yellow/Green
- 2 = Black
- 3 = Blue
- 4 = Brown
- 5 = White (TW)
- 6 = Orange
- 7 = Grey
- 8 = Red
- 9 = Green
- 10 = Violet

Accessories

Accessories



TFU 560