

## Description

RK is a range of straight flow in-line centrifugal duct fans designed for rectangular ducts. They are compact, high capacity fans which operate quietly and can be fitted in any position. RK fans have forward curved impellers and are designed to cope with high pressure and long duct. The fans have a rigid housing made from galvanised steel. They are moisture proof and approved for use in outdoor environments. The motors are maintenance free and protected from overheating by thermo contacts. The impellers only require occasional cleaning. This cleaning is made easy with the RK's swing out design. All fans are supplied fully wired and ready to fit in a sealed installation unit. The fans are not intended for transporting grinding dust, soot or similar. RK fans come in 8 sizes, which gives a total of 24 different capacities.



## Technical data

Parameter	Value	Unit
Voltage	230	V
Phase	1	~
Frequency	50	Hz
Power	0.89	kW
Current	4.1	A
R.p.m.	13	r/s
Max. temperature of transported air	55	°C
Max. temperature of transported air when speed-controlled	55	°C
Sound pressure level at 3 m	56.2	dB(A)
Length	717	mm
Width	643	mm
Height	414	mm
Weight	38	kg
Enclosure class, motor	44	IP
Insulation class, motor	F	
Capacitor	16	µF
Duct connection	600x350 mm	

Diagrams

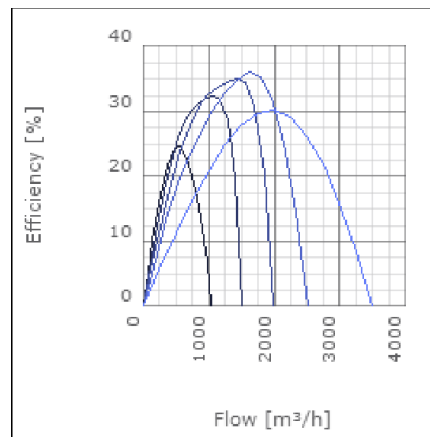
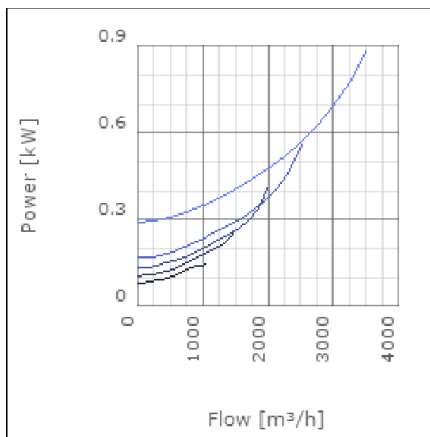
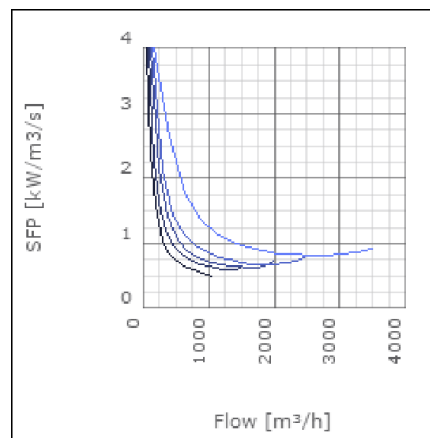
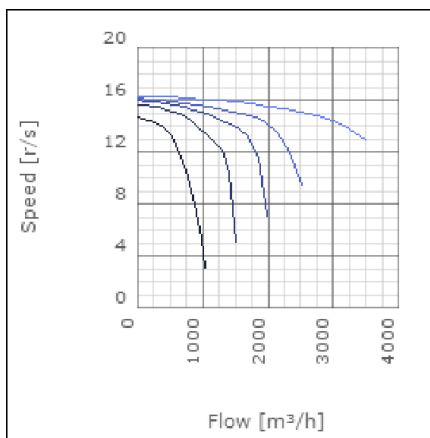
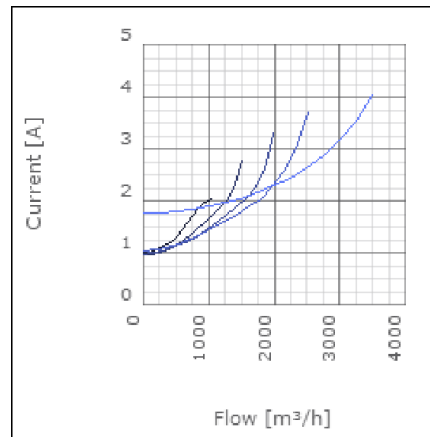
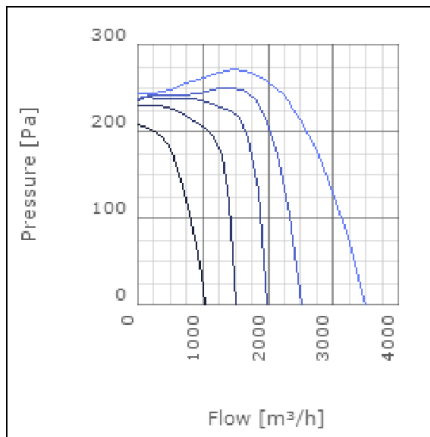

Sound

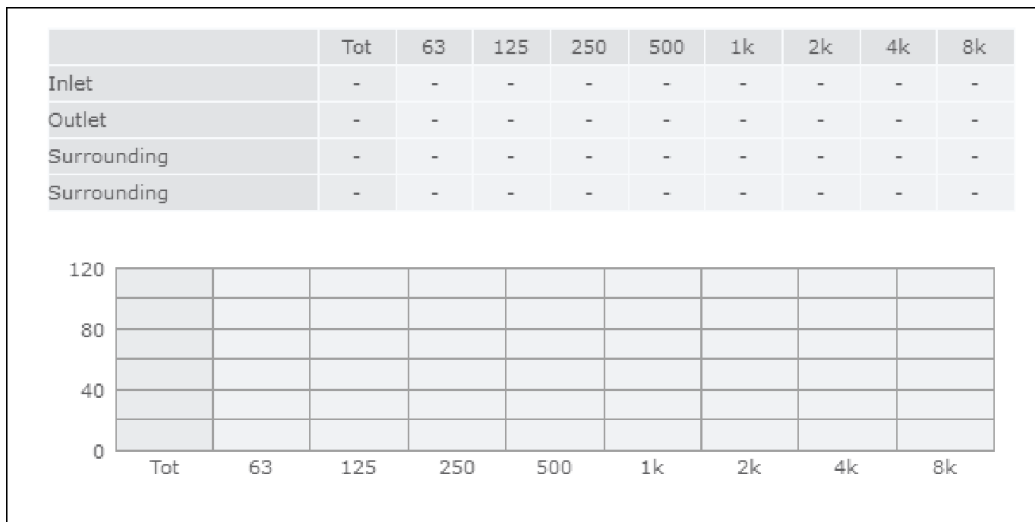
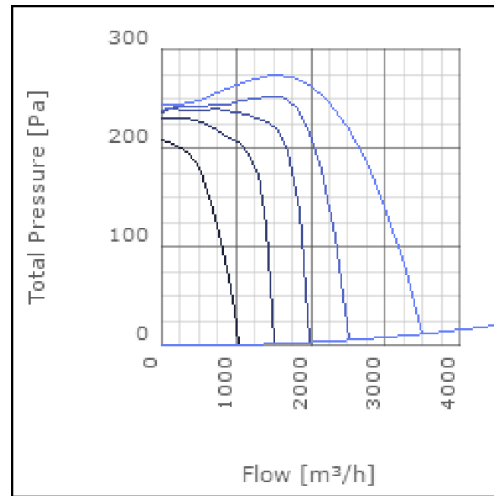
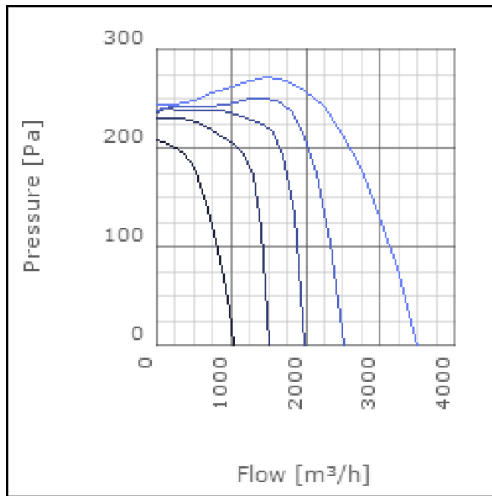

**Parameter**

Distance: 3.000  
 Propagation type: Hemi-spherical  
 Equivalent absorption area: 20.00

## Dimensions

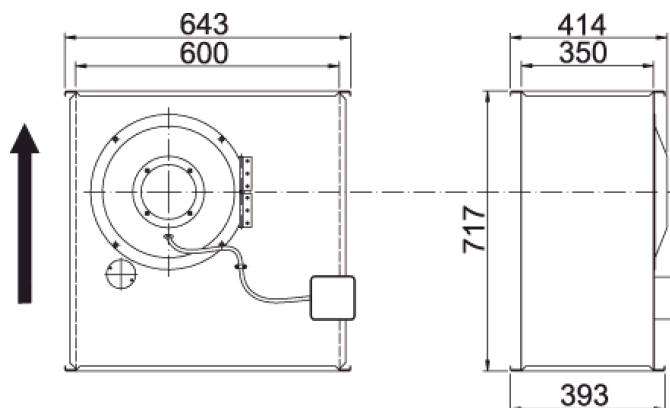

## Wiring diagram

4040005

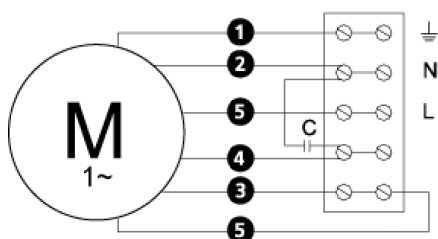

- (M) = Fan Motor
- (M1) = Fan Motor
- (M2) = Fan Motor
- (M3) = Rotor Motor
- 1 = Yellow/Green
- 2 = Black
- 3 = Blue
- 4 = Brown
- 5 = White (TW)
- 6 = Orange
- 7 = Grey
- 8 = Red
- 9 = Green
- 10 = Violet

## Accessories

- ETFV-94A
- FRE 6
- VRDE 7
- VRTE 5

## Electrical accessories

- FLR 600x350
- DS 600x350
- RKC-Kit 355 (600x350)
- LDR 600x350