

TKV/TKH 960 C3

Description

Our new, unique and patent pending roof fans you can easily modify for either horizontal or vertical outlet. Equally easy to clean and maintain. They achieve a higher airflow compared to the previous models but with even lower sound levels.

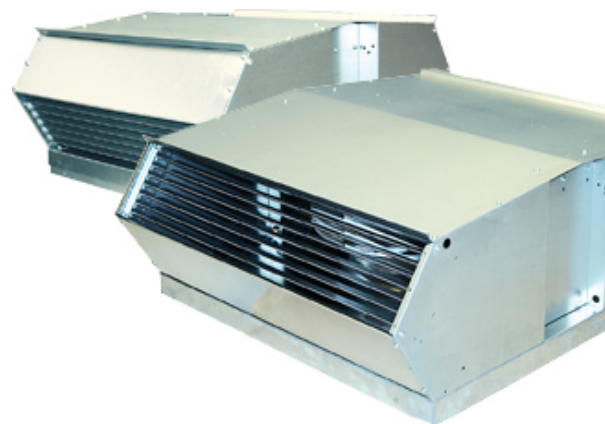

Technical data

Parameter	value	Unit
Voltage	400	V
Phase	3	~
Frequency	50	Hz
Power	1880	W
Current	3,8	A
R.p.m.	1400	r.p.m.
Max. temperature of transported air	50	°C
Max. temperature of transported air when speed-controlled	50	°C
Sound pressure level at 10 m	64	dB(A)
Weight	78	kg
Enclosure class, motor	44	IP
Insulation class, motor	F	
Capacitor	-	µF

Diagrams

○ Selected point

Flow [l/s]	1821
Stat. pres. [Pa]	528
● Work point	
Flow [l/s]	1820
Stat. pres. [Pa]	528
Power [W]	1889
Current [A]	3,85
Speed [r.p.m.]	-
Efficiency [%]	50,9
SFP [kW/m ³ /s]	1,02
Voltage [V]	400

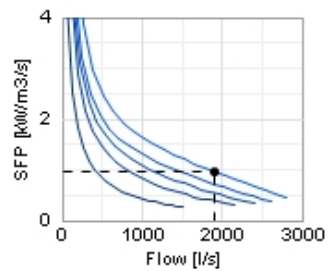
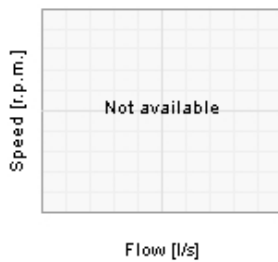
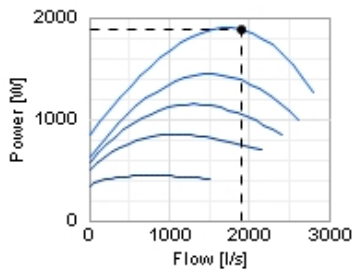
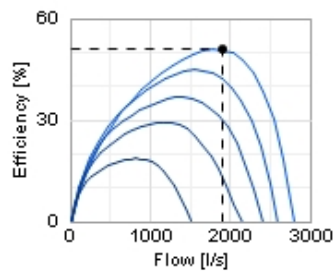
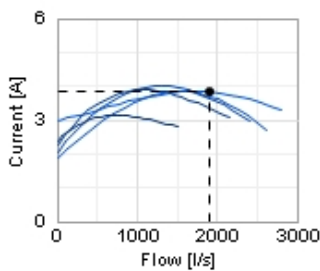
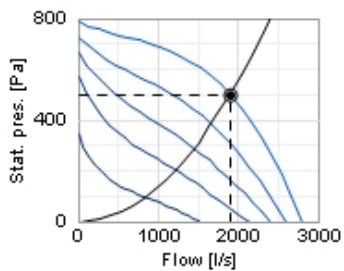

Sound

○ Selected point

Flow [l/s]	1900
Stat. pres. [Pa]	502
● Work point	
Flow [l/s]	1900
Stat. pres. [Pa]	502
Total press. [Pa]	537
Power [W]	1879
Current [A]	3,84
Speed [r.p.m.]	-
Efficiency [%]	50,7
SFP [kW/m ³ /s]	0,975
Voltage [V]	400

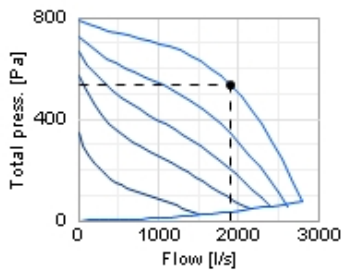
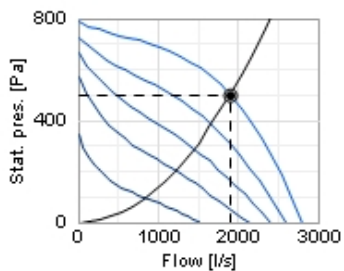

Distance: 3

Propagation type: Semi-spherical

Equivalent absorption area: 20

	Tot	63	125	250	500	1k	2k	4k	8k
Inlet Lw dB(A)	87	69	78	78	78	81	81	75	67
Surrounding Lw dB(A)	91	57	71	85	85	87	84	78	70
Surrounding Lp dB(A)	85	50	64	78	78	80	77	71	63

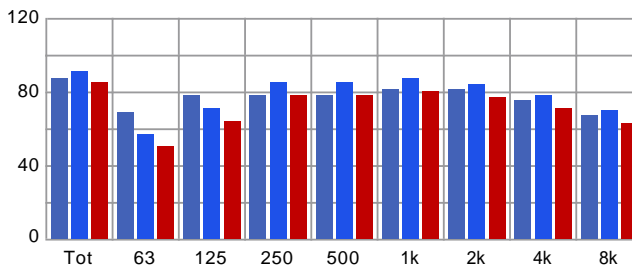

Dimensions

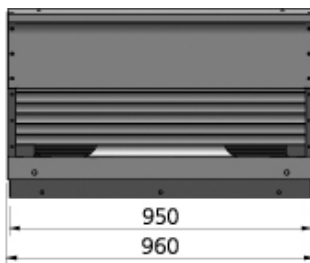
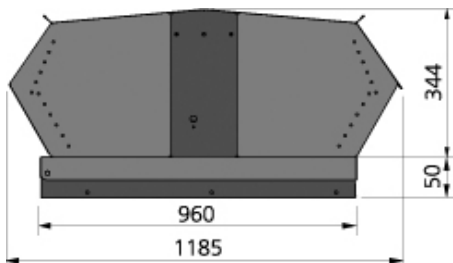

Wiring diagram

4040004

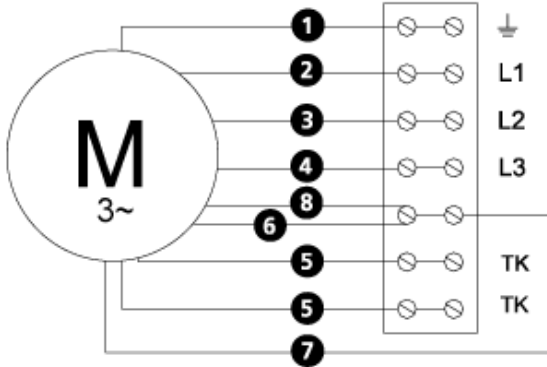

- Ⓜ = Fan Motor
- Ⓜ1 = Fan Motor
- Ⓜ2 = Fan Motor
- Ⓜ3 = Rotor Motor
- 1 = Yellow/Green
- 2 = Black
- 3 = Blue
- 4 = Brown
- 5 = White (TW)
- 6 = Orange
- 7 = Grey
- 8 = Red
- 9 = Green
- 10 = Violet

Accessories

Accessories



TFU 960